

Isotta is a circular light fixture for ceiling and wall. Thanks to a simple but original design with side openings all around the body and a wide emission surface it enriches indoor and outdoor spaces of an even soft light. Highly decorative and compact, Isotta is a very reliable working element allowing long term projects.



**Description**

Round luminaire for outdoor surface installation on wall, on ceiling or on dedicated post. Configuration: phospho-chromatised and polyester powder coated die-cast aluminium structure with coated die-cast aluminium (four colours available) finish frames, moulded silicone gasket and self-extinguishing opal polycarbonate diffuser.

**Versions Available**

Diffuser: self-extinguishing opal polycarbonate  
 Light emission: front and lateral 360° emission through side openings all around the structure

**Light Source**

- 100W QT32 E27 halogen lamp
- 2x60W QT32 E27 halogen lamp
- 26W TC-D G24d-3 compact fluorescent lamp

**Dimensions**

- Luminaire:  
 Round frame: Ø 304mm  
 Width: 100mm
- Post:  
 Length: 300mm  
 Height: 500mm or 1000mm  
 Width: 80mm + 100mm (luminaire)
- Base:  
 - length: 370mm  
 - width : 150mm

**Technical Features**

Protection Rating: IP65 • in compliance with EN 60598-1 standards  
 Class of insulation: I

**Installation**

Wiring through a rubber cable holder for Ø<10mm cables. Outdoor use requires suitable flexible cables assuring the watertightness of the cable holder.

**Colours Available**

-  .1 white
-  .2 aluminium
-  .3 anthracite
-  .4 black

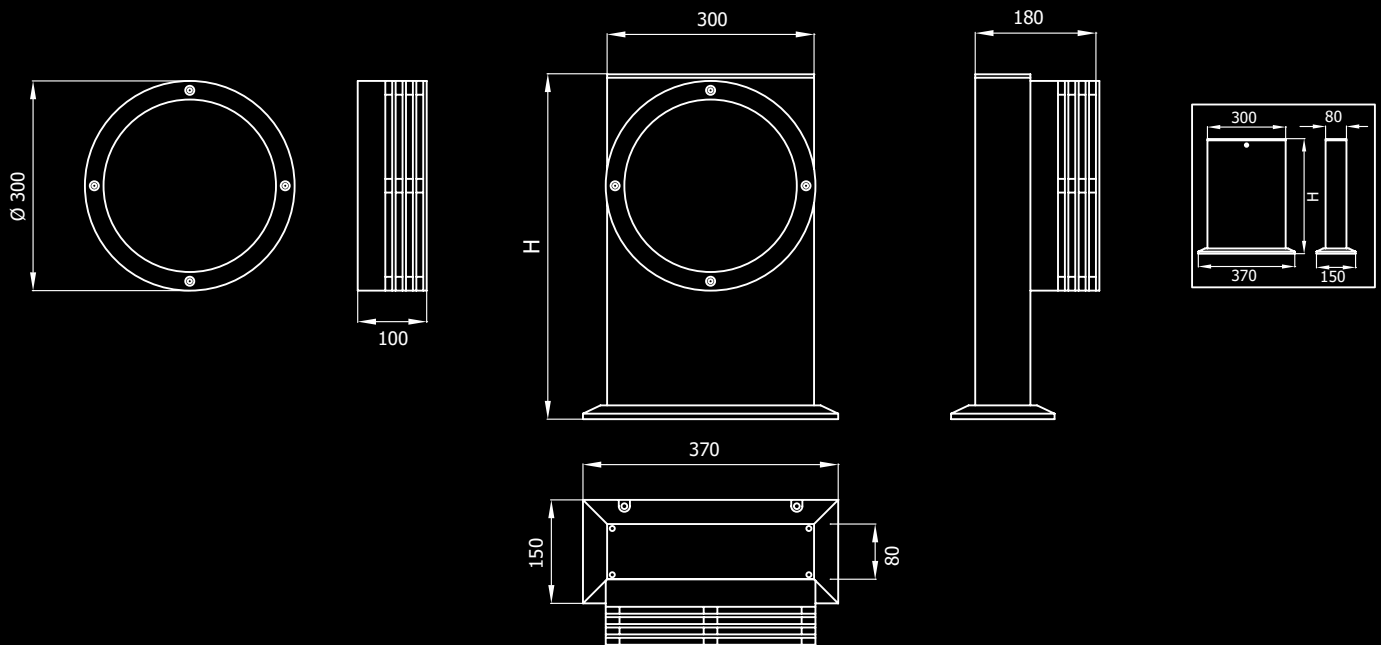
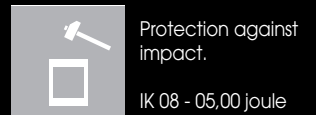

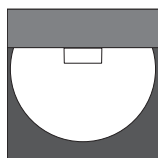

400100  
QT32 100W E27

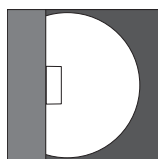
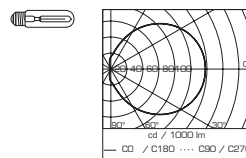

400200  
QT32 2x60W E27

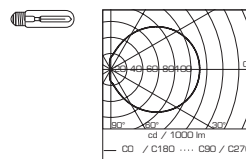

400900  
TC-D 26W G24 d-3

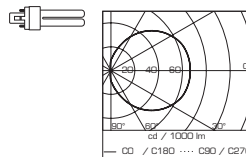

POLES WITH BASE

2305  
H 500 MM

2310  
H 1000 MM

